



5000 SERIES TRACTOR OPERATORS MANUAL

R

OPERATING INSTRUCTIONS FOR ALL GRAVELY 5000 SERIES TRACTORS ARE INCLUDED IN THIS BOOK.

The tractor must be maintained and operated according to this Operator's Manual.

All references to "left side", "right side", "front", and "back" are given from the operator's position.

It is important that you make a record of the Tractor Serial Number, Engine Model Number, and Engine Specification Number for your future use. Write the numbers in the spaces below.

Tractor Serial Number _____

Engine Model Number _____

Engine Specification Number _____

LEARN ABOUT YOUR TRACTOR

Read this Operator's Manual carefully and learn how to operate and do maintenance on your tractor before use.

Learning how to use your tractor is part of doing the job. Learn how to start, turn, change direction, change speeds and stop. Know what the tractor can do.

It is very important that the Warnings - For Your Safety are read, learned and followed. See Section 1.0. Use caution, SAFETY FIRST!

ABOUT THE WARRANTY

It is the purchaser's responsibility to make sure that the tractor is operated and the maintenance is done as shown in this book. A failure caused by bad maintenance or using the tractor in the wrong way stops the warranty.

Read the Limited Warranty on the inside back cover of this Operator's Manual.

CONTENTS

1.0	Warnings - For Your Safety
1.1	Instructions Before Operation
1.2	Preparation for Operation
1.3	Operation
2.0	Controls and Instruments
2.1	The Direction Control Lever
2.2	The Gear Shift Lever
2.3	The Range Shift Handle
2.4	The Throttle Lever
2.5	The Choke Control
2.6	The PTO Control Handle
2.7	The Ignition Switch
2.8	The Hourmeter
2.9	The Ammeter
2.10	The Fuse Holder
2.11	The Tractor Stand
3.0	How To Operate The Tractor
3.1	How To Start and Stop An Engine That Has An Electric Starter
3.2	How To Start and Stop An Engine That Has A Manual Starter
3.3	How To Move The Tractor In A Forward Or Reverse Direction
3.4	How To Operate The PTO
3.5	Correct Operating Procedure
3.6	How To Operate The Tractor In A Stationary Position
4.0	How To Do Maintenance
4.1	How To Check The Level Of The Lubricant In The Engine
4.2	How To Check The Cooling System
4.3	How To Check The Air Cleaner Element
4.4	How To Lubricate The Pivots Of The Control Levers
4.5	How To Change The Lubricant In The Engine
4.6	How To Check The Level Of The Battery Fluid
4.7	How To Check The Fasteners
4.8	How To Adjust The Direction Control Clutch
4.9	How To Adjust The Gear Shift Clutch
4.10	How To Adjust The Slip Clutch
4.11	How To Replace The Air Cleaner Element
4.12	How To Clean The Spark Plug
4.13	How To Check The Level Of The Lubricant In The Transmission
4.14	How To Clean The Battery
5.0	How To Put The Tractor In Storage
6.0	How To Take The Tractor Out Of Storage
7.0	How To Check For Problems With The Tractor
7.1	The Electric Starter Will Not Operate
7.2	The Engine Is Difficult To Start Or Has A Loss Of Power
7.3	The Tractor Will Not Move When The Direction Control Lever Is Moved
7.4	The Attachment Will Not Operate Or Operates Slowly
7.5	The Ammeter Shows That The Electrical System Is Discharging



1.0



WARNINGS - FOR YOUR SAFETY



NOTE: This warning symbol  indicates that there is danger to persons or equipment. Read these warnings carefully and follow them.

This section gives warnings for you about operating and doing maintenance on this equipment.

Using this equipment the wrong way can cause injury to persons and damage to the equipment. Persons operating or doing maintenance on this equipment must read this Operator's Manual and follow the instructions.

It is important to understand that this Operator's Manual and other Gravely instruction books do not list every possible danger. It is not possible for Gravely to know and tell of all the dangers in operating and doing maintenance on the equipment. The purchaser must give these instructions to the persons operating and doing maintenance on this equipment. The purchaser must get the operator and person doing maintenance on this equipment to use eye and foot protection.

1.1 Instructions Before Operation

1. Read the tractor Operator's Manual and the attachment Operator's Manual carefully before operating or doing maintenance.
2. Learn the location and function of all tractor and the attachment controls.
3. Know how to use the controls to stop the tractor and the attachment quickly.
4. Never permit children to operate or to ride on the tractor or the attachment.
5. Use caution with gasoline. Gasoline is very flammable. Keep gasoline in a clean and tight container. Keep gasoline away from fire or hot items. Never put gasoline in the fuel tank while the engine is running or hot. Clean any gasoline from the equipment before starting the engine.

1.2 Preparation For Operation

1. Keep all shields, guards and safety interlock switches in the correct position.
2. Wear strong shoes and clothing that is not loose when operating the tractor. Wear protection for your eyes.
3. Before starting the engine, put the direction control lever in the "NEUTRAL" position and PTO control in the "DISENGAGE" position.
4. Do not operate the tractor where the work area is too dark for the operator to see.
5. Keep the tractor in good operating condition. Do the maintenance as shown in this Operator's Manual.
6. Never operate the tractor or the attachment when there is damage to any part or any part is not in the correct position. Replace all parts that are damaged or missing before operating.
7. Use only Gravely accessories and attachments shown by Gravely to be correct for use with the tractor.

1.3 Operation

1. Do not change the governor so the engine will run over 3600 revolutions per minute.
2. Keep away from moving parts.
3. Keep all persons and animals away from the area of operation.
4. Do not let persons other than the operator ride on the tractor.
5. When operating on slopes, use a slow tractor speed and engage the direction control lever slowly.
6. Always look for and keep away from holes and other hazards.
7. Use more caution when moving backwards. Look for persons and danger in the way.
8. After hitting an object, stop the tractor and engine and check for damage. If there is damage, make repairs before restarting.
9. Operate the equipment only when in the operator's position at the handlebars of the tractor.
10. Travel across slopes, not up and down.
11. When moving the tractor on a transport, connect the chassis and the rear hitch of the tractor to the transport. Never connect from the control levers, rods, or items that can be damaged.
12. Before leaving the tractor, put the PTO control in the "OFF" position. Turn the ignition switch to the "OFF" position. Remove the key from the ignition switch.
13. If there is a sudden change in the sound or vibration of the tractor or the attachment, stop the tractor and the engine. If there is damage, make repairs before operating the tractor or the attachment.
14. Never start and run the engine inside a building except to move the equipment outside. Exhaust fumes are dangerous.
15. Go slow on surfaces where the tractor can slide.
16. Always follow traffic laws while going on or near a road.
17. Before leaving the operator's position to make adjustments or to do maintenance, put the PTO control in the "OFF" position, turn the ignition switch to the "OFF" position and wait until the engine and moving parts have stopped.



2.0 CONTROLS AND INSTRUMENTS



WARNING: Do not use gasohol in small engines.

This section gives the location of the controls and instruments and how they are used.

2.1 The Direction Control Lever

The direction control lever controls the forward and backward movement of the tractor. Push the direction control lever forward to cause the tractor to move forward. Pull the direction control lever backward to cause the tractor to move backward. See figure 2.0-1 for the location of the direction control lever.

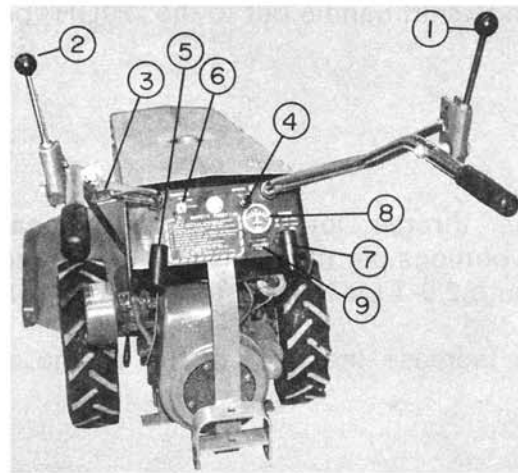

- 1 - Direction Control Lever
- 2 - Gear Shift Lever
- 3 - Throttle Lever
- 4 - Choke Control (Electric Start Shown)
- 5 - PTO Control Handle
- 6 - Ignition Switch
- 7 - Range Shift Handle
- 8 - Ammeter
- 9 - Hourmeter

Figure 2.0-1

2.2 The Gear Shift Lever

The gear shift lever has two positions that will change the speed of the tractor and a "NEUTRAL" position. The gear shift lever also changes the revolutions per minute (RPM) of the power take-off (PTO). See figure 2.0-1 for the location of the gear shift lever.

To increase the speed of the tractor and the RPM of the PTO, push the lever forward to the "HIGH" position.

To decrease the speed of the tractor and the RPM of the PTO, pull the lever backward to the "LOW" position.

When the lever is in the vertical position the gears are in the "NEUTRAL" position.

NOTE: The gear shift lever must be in the "HIGH" position or the "LOW" position to operate the tractor and the PTO.

2.3 The Range Shift Handle

The range shift handle is also used to change the speed of the tractor. See figure 2.0-1 for the location of the range shift handle.

NOTE: All 5000 Series tractors do not have a range shift handle.

To increase the speed of the tractor, pull the range shift handle out to the "HIGH" position.

To decrease the speed of the tractor, push the range shift in to the "LOW" position.

! WARNING: Never move the handle while on a slope or while the tractor is moving. Move the handle only when on level ground and the tractor is stopped.

2.4 The Throttle Lever

The throttle lever is used to change the revolutions per minute (RPM) of the engine. See figure 2.0-1 for the location of the throttle lever.

To increase the RPM of the engine, push the

throttle lever up to the "FAST" position.

To decrease the RPM of the engine, push the throttle lever down to the "SLOW" position.

2.5 The Choke Control

The choke control is used to start a cold engine. See figure 2.0-1 for the location of the choke control on tractors that have electric start. See figure 2.0-2 for the location of the choke control on tractors that have manual start.

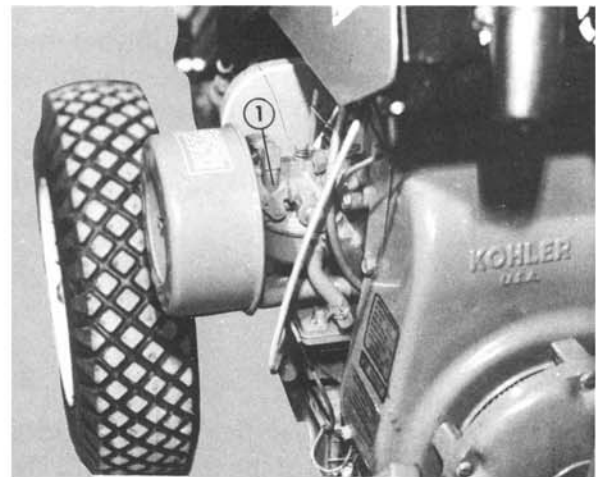

1 - Choke Control

Figure 2.0-2

2.6 The PTO Control Handle

The PTO control handle is used to engage or disengage the power take-off (PTO) that gives power to the attachments. Pull the PTO control handle backward to engage the PTO. Push the PTO control handle forward to disengage the

PTO. See figure 2.0-1 for the location of the PTO control handle.

NOTE: The gear shift lever must be in the "NEUTRAL" position before engaging the PTO.

2.7 The Ignition Switch

The ignition switch is used to start, run and stop the engine. The ignition switch has a key that must be used to operate the ignition switch. See figure 2.0-1 for the location of the ignition switch.

2.8 The Hourmeter

The hourmeter shows the number of hours the tractor has been operated. See figure 2.0-1 for the location of the hourmeter.

NOTE: The hourmeter is not on all 5000 Series tractors.

2.9 The Ammeter

The ammeter shows if the electrical system of the tractor is charging the battery. See figure 2.0-1 for the location of the ammeter.

NOTE: The ammeter is not on all 5000 Series tractors.

2.10 The Fuse Holder

The tractors that have electric starters have a fuse holder. The fuse holder has a fuse that protects the electrical system. A failure of the fuse will stop the engine. See Figure 2.0-3 for the location of the fuse holder..



1 - Fuse Holder

Figure 2.0-3

2.11 The Tractor Stand

The tractor stand is used to hold the rear of the tractor off the ground when an attachment has been removed. Always raise the stand when an attachment is installed or when moving the tractor. See figure 2.0-4 for the location of the tractor stand.

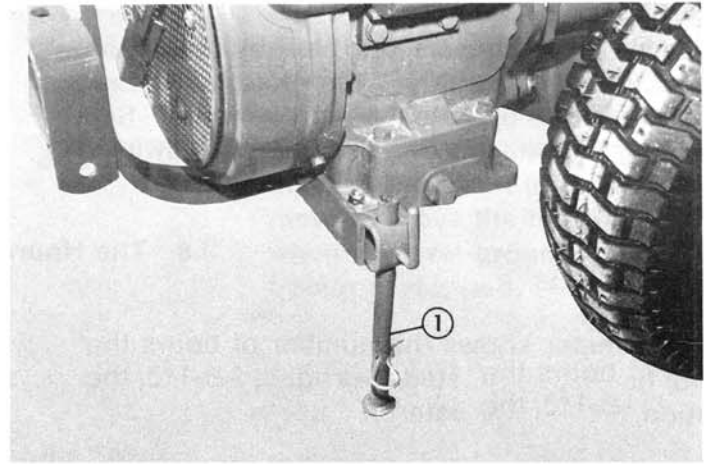

1 - Tractor Stand

Figure 2.0-4



3.0 HOW TO OPERATE THE TRACTOR



Read this Operator's Manual before operating the tractor. Read the Operator's Manual for the attachment to be used. Operate the tractor only from the operator's position and follow the Warnings - For Your Safety.

Before starting the engine, do the daily maintenance as shown in Section 4.0.

WARNING: Do not get in between the handlebars when operating the tractor.

3.1 How to Start and Stop an Engine that has an Electric Starter

To start the engine, the direction control lever must be in the "NEUTRAL" position. The PTO control handle must be in the "OFF" position.

1. Put the key in the ignition switch.
2. Move the throttle lever half-way toward the "FAST" position.
3. If the engine is cold, pull the choke control out. If the engine is warm or hot, do not move the choke control.

4. Turn the key in the ignition switch to the "START" position. When the engine starts, release the key. When the engine is running smoothly, push the choke control all the way in.
5. If the engine does not start in five seconds, pull the choke control out and try again. If the engine does not start after trying this procedure, see Section 6.0 for instructions.

NOTE: Do not keep the starter engaged for more than 15 seconds. Do not engage the starter more than 15 seconds in one minute.

6. Before stopping the engine, put the PTO control handle in the "OFF" position. Move the throttle lever to the "SLOW" position.
7. To stop the engine, turn the key in the ignition switch to the "OFF" position. When the engine stops, put the direction control lever in the "FORWARD" position. Always remove the key from the ignition switch when leaving the tractor.

3.2 How to Start and Stop an Engine that has a Manual Starter

To start the engine, the direction control lever must be in the "NEUTRAL" position. The PTO control handle must be in the "OFF" position.

1. Put the key in the ignition switch. Turn the key in the ignition switch to the "ON" position.
2. Move the throttle lever half-way toward the "FAST" position.
3. If the engine is cold, move the choke control all the way to the left as shown in figure 3.0-1. If the engine is warm or hot, do not move the choke control.

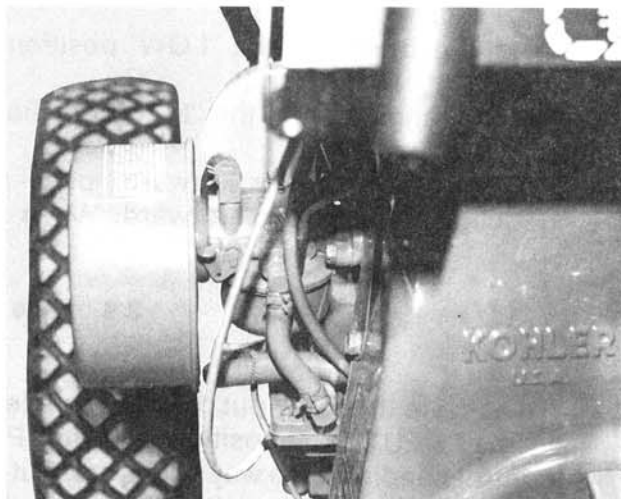

Figure 3.0-1

4. Pull the starter handle out with a continuous motion. See figure 3.0-2.

NOTE: Hold the starter handle and let the rope rewind slowly.

5. When the engine starts, and is running, move the choke control all the way to the right.
6. If the engine does not start repeat step 4. If the engine does not start after trying step 4 six times, see Section 6.0 for instructions.
7. Before stopping the engine, put the PTO control handle in the "OFF" position. Move the throttle lever to the "SLOW" position.
8. To stop the engine, turn the key in the ignition switch to the "OFF" position. When the engine stops, put the direction control lever in the "FORWARD" position. Always remove the key from the ignition switch when leaving the tractor.

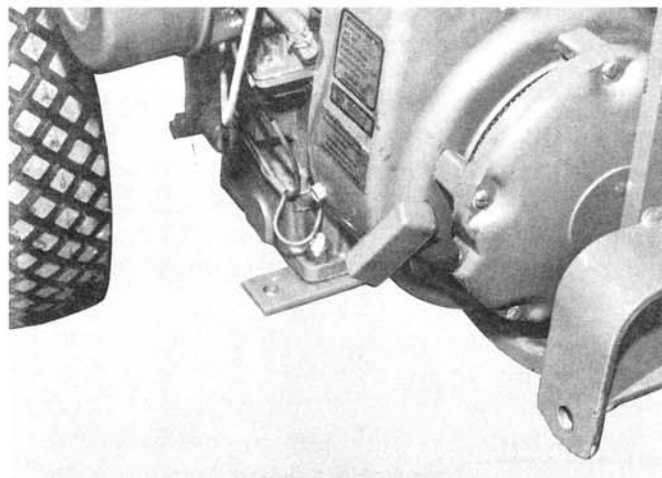

Figure 3.0-2

3.3 How to Move the Tractor in a Forward or Reverse Direction

Learn to operate the tractor in an open area, using a slow tractor speed. Do not activate the attachment until you know how to control the tractor.

1. Start the engine and wait until the engine is running smoothly.
2. Move the throttle lever to the "FAST" position.
3. Put the gear shift in the "LOW" position.
4. Put the range shift in the "LOW" position.
5. To move the tractor forward, push the direction control lever forward. When the

tractor is moving, push the direction control lever until it stops and holds in position. If the lever is not pushed all the way forward, damage can be caused to the clutch.

6. To move the tractor backward, pull the direction control lever backward. The tractor will move backward only as long as the direction control lever is pulled backward.

⚠ WARNING: Be careful while learning to operate the tractor.

7. To stop the tractor, put the direction control lever in the "NEUTRAL" position.

3.4 How to Operate the PTO

1. To activate the PTO, put the gear shift lever in the "NEUTRAL" position. Pull the PTO control handle all the way backward. Put the gear shift lever in the position that is needed.

NOTE: The gear shift lever must be in either the "LOW" position or the "HIGH" position to operate the tractor or the PTO.

2. To deactivate the PTO, push the PTO control handle all the way forward.

3.5 Correct Operating Procedure

Read the Warnings - For Your Safety in Section 1.0.

2. Use a slow speed when operating on rough ground and slopes.
3. Use a slow speed when operating a mower in high grass.
4. Use a slow speed when operating near buildings or other objects.
5. Use a slow speed when operating a snow-blower or the rotary cultivator.
6. Never walk between the handlebars when operating the tractor.
7. When operating on a slope, go across the slope, not up and down the slope.
8. Move the throttle lever to the "FAST" position when operating the tractor. Use the gear shift or the range shift to control the speed of the tractor.

3.6 How to Operate the Tractor in a Stationary Position

The tractor is operated in a stationary position when using attachments such as the log splitter or the compost shredder.

1. Put blocks in front of the tires and in back of the tires. The blocks must be against the tires.
2. Start the engine. Wait until the engine is

running smoothly before operating.

3. Activate the attachment only from the operator's position.



WARNING: When leaving the operator's position, keep away from moving parts.



4.0 HOW TO DO MAINTENANCE



It is important that the maintenance items shown in the tractor maintenance schedule, figure 4.0-1, be done at the correct time interval. Correct maintenance can increase the life of the tractor and the engine.

The maintenance items are shown in the left column of the tractor maintenance schedule. The correct time interval of each maintenance item is shown by the mark "X" in the daily, 25 hours, 100 hours, and 200 hours columns. Do each maintenance item at the correct time interval.

Tractor Maintenance Schedule

Maintenance Items	Location	Time Intervals For Maintenance			
		Daily	25 Hours	100 Hours	200 Hours
Check the Level of the Lubricant in the Engine	Section 4.1	X			
Check the Cooling System	Section 4.2	X			
Check the Air Cleaner Element	Section 4.3	X			
Lubricate the Pivots of the Control Levers	Section 4.4		X		
Change the Lubricant in the Engine	Section 4.5		X		
Check the Level of the Battery Fluid	Section 4.6		X		
Check the Fasteners	Section 4.7		X		
Adjust the Direction Control Clutch	Section 4.8		X		
Adjust the Gear Shift Clutch	Section 4.9		X		
Adjust the Slip Clutch	Section 4.10			X	
Replace the Air Cleaner Element	Section 4.11			X	
Clean the Spark Plug	Section 4.12			X	
Check the Level of the Lubricant in the Transmission	Section 4.13			X	
Clean the Battery	Section 4.14				X

Figure 4.0-1

4.1 How to Check the Level of the Lubricant in the Engine

Each day, check the level of the lubricant in the engine. Never operate the engine when the level of the lubricant is below the mark on the dipstick that indicates the level is low. If the level of the lubricant is low, add new lubricant that has the specifications shown in figure 4.0-2.

Engine Lubricant Specifications

Grade -- API Service SC, SD, or SE

Viscosity -- 10W-40
Below 0°F (-18 C) use 5W-20

Figure 4.0-2

1. Stop the engine.
2. Clean the area around the dipstick and the tube to prevent dirt from falling into the tube. See figure 4.0-3.
3. Pull the dipstick out of the tube and clean the dipstick.
4. Push the dipstick all the way down into the tube.
5. Pull the dipstick out of the tube and look at the level of the lubricant.
6. Add lubricant if the level is below the mark that indicates the level is low. Add lubricant until the level is at the mark on the dipstick that indicates the level is correct.
7. Push the dipstick all the way into the tube.

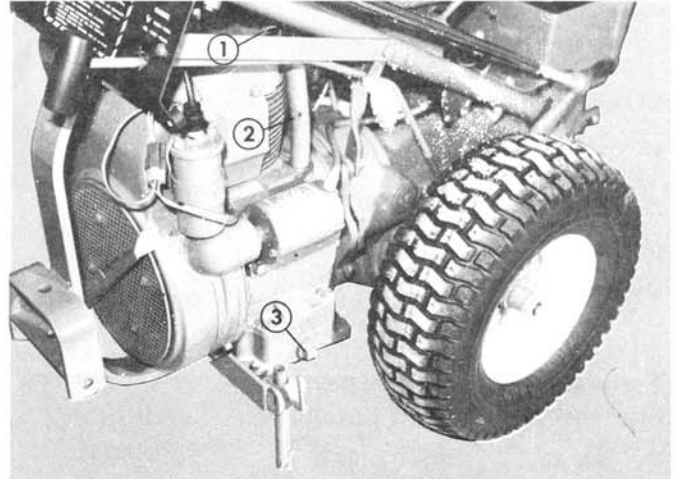

- 1 - Dipstick
- 2 - Tube
- 3 - Drain Plug

Figure 4.0-3

4.2 How to Check the Cooling System

⚠ WARNING: Stop the engine before checking the cooling system.

Each day, check the cooling system for grass and other material.

1. Clean all the grass and other material from the air intake screen at the back of the engine.
2. Clean all the grass and other material from the cooling fins of the engine. If necessary, remove the engine cover to clean the engine.

NOTE: Do not run the engine without the engine cover fastened in position.

4.3 How to Check the Air Cleaner Element

Each day, check the air cleaner.

1. Turn the wing nut on the air cleaner cover counterclockwise. Remove the wing nut and the cover. See figure 4.0-4.
2. Remove the air cleaner element.

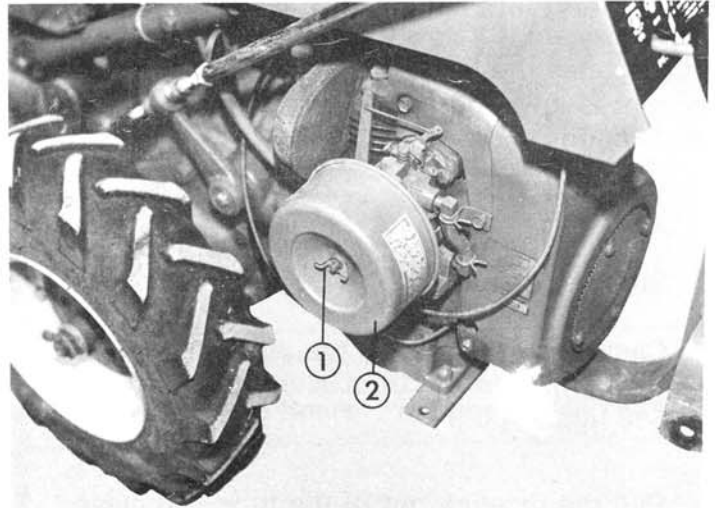

1 - Wing Nut
2 - Cover

Figure 4.0-4

3. To clean the air cleaner element, hit the element lightly on a flat surface. See figure 4.0-5.

NOTE: If the air cleaner element has damage, the element must be replaced.

4. Clean all the dirt from the air cleaner base plate and the cover.
5. Install the air cleaner element carefully to prevent dirt from entering the engine.
6. Install the air cleaner cover and the wing nut.

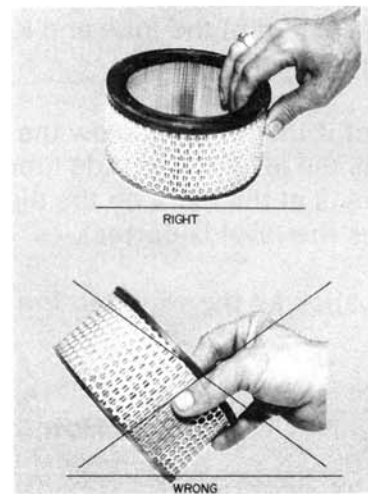

Figure 4.0-5

4.4 How to Lubricate the Pivots of the Control Levers

After every 25 hours of operation, put a drop of engine lubricant on the pivots of the throttle lever, the direction control lever, the gear shift lever, the PTO control and the range shift.

NOTE: There are no grease fittings on the tractor.

4.5 How to Change the Lubricant in the Engine

NOTE: After the first eight hours of operation, change the lubricant in the engine.

After every 25 hours of operation, change the lubricant in the engine. When operating in dirty conditions, decrease the time interval. Use lubricant that has the specifications as shown in figure 4.0-2.

1. If the engine is cold, start the engine. Let the engine run five minutes at a slow RPM.

⚠ WARNING: Stop the engine before changing the lubricant in the engine.

2. Open the hood of the tractor.

⚠ WARNING: The muffler and other parts of the engine are hot.

3. Clean the area around the dipstick, the tube and the drain plug. See figure 4.0-6.
4. Remove the dipstick from the tube.
5. Put a four quart (4 liter) container under the drain plug.
6. Turn the drain plug counterclockwise and remove the plug.
7. Drain all the old lubricant from the engine. Install the drain plug.

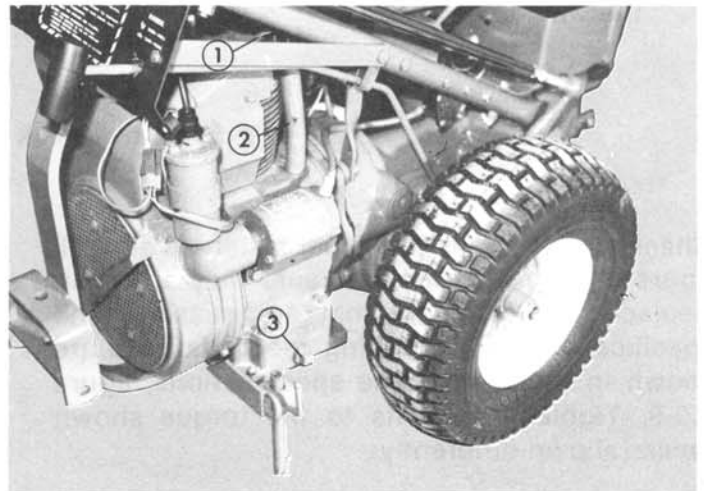

- 1 - Dipstick
- 2 - Tube
- 3 - Drain Plug

Figure 4.0-6

8. Add new lubricant until the level of the lubricant is at the mark on the dipstick that indicates the level is correct. See figure 4.0-7 for the correct amount of lubricant to add.
9. Install the dipstick in the tube.
10. Start the engine and check for a leak at the drain plug. If there is a leak, tighten or replace the drain plug.

Engine Lubricant Capacity

Kohler, 8 Horsepower	- 1.25 U.S. quarts (1.2 liters)
Kohler, 10 Horsepower	- 2 U.S. quarts (1.9 liters)
Kohler, 12 Horsepower	- 2 U.S. quarts (1.9 liters)

Figure 4.0-7

4.6 How to Check the Level of the Battery Fluid

After every 25 hours of operation, check the level of the fluid in the battery.

NOTE: Only the tractors that have an electric starter have a battery.

1. Stop the engine and open the hood.

⚠ WARNING: Wear protection for your eyes when checking the battery. Never use a funnel that is metal to add water to the battery.

2. Remove the filler caps from the battery. See figure 4.0-8.
3. If the level of the fluid is below the split ring in the filler tube, add distilled water. Add only enough water to bring the level of the fluid up to the split ring in the filler tube.
4. Install the filler caps. Push the filler caps all the way down.

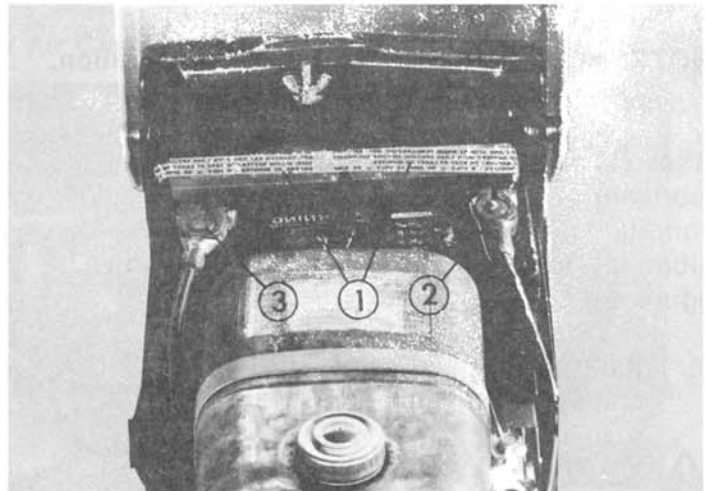

- 1 - Filler Caps
- 2 - Positive Terminal
- 3 - Negative Terminal

Figure 4.0-8

4.7 How to Check the Fasteners

Check all nuts, bolts and other fasteners after 25 hours of operation to make sure they are tight. Replace any fasteners that are missing. The specifications for tightening the bolts used are shown in the bolt torque specifications, figure 4.0-9. Tighten the bolts to the torque shown unless shown differently.

BOLT TORQUE SPECIFICATIONS		
BOLT SIZE	FOOT POUNDS (ft. lbs.)	NEWTON METERS (N.m)
1/4"	7	9.5
5/16"	14	19
3/8"	25	34
7/16"	40	54
1/2"	60	82
9/16"	83	113
5/8"	120	163
3/4"	200	271

Figure 4.0-9

4.8 How to Adjust the Direction Control Clutch

After every 25 hours of operation, check the adjustments of the direction control clutch.

⚠ WARNING: Stop the engine before adjusting the direction control clutch.

The reverse adjustment is correct if the reverse clutch is activated when the direction control lever is 15° beyond the vertical position.

The forward adjustment is correct if the large spring has a clearance of .010" (.254 mm) between the coils of the spring when the direction control lever is pushed all the way forward.

1. Loosen the jam nuts on each side of the actuating lever. See figure 4.0-10.
2. Use your hand to push the actuating lever all the way toward the rear.
3. Adjust the inside jam nut on the front side of the lever so that the direction control lever will be 15° beyond the vertical position, towards the rear of the tractor.
4. Tighten the outside jam nut against the inside jam nut. Do not move the inside jam nut.
5. To adjust the forward clutch, push the direction control lever all the way forward. Make sure the direction control lever goes into a holding position.
6. Adjust the inside jam nut until there is a clearance of .010" (.254 mm) between the coils of the large spring.
7. Tighten the outside jam nut against the inside jam nut. Do not move the inside jam nut.



- 1 - Jam Nut
- 2 - Large Spring
- 3 - Actuating Lever

Figure 4.0-10

4.9 How to Adjust the Gear Shift Clutch

After every 25 hours of operation, check the adjustments of the gear shift clutch.

⚠ WARNING: Stop the engine before adjusting the clutch.

The adjustments are correct if the spring has a clearance of .010" (.254 mm) between the coils of the spring when the gear shift lever is in the "HIGH" position and in the "LOW" position.

1. Loosen the jam nuts on each side of the actuating lever. See figure 4.0-11.
2. Push the gear shift lever forward to the "HIGH" position.
3. Adjust the inside jam nut behind the actuating lever until there is a clearance of .010" (.254 mm) between the coils of the spring.
4. Tighten the outside jam nut against the inside jam nut. Do not move the inside jam nut.
5. Pull the gear shift lever backward to the "LOW" position.
6. Adjust the inside jam nut in front of the actuating lever until there is a clearance of .010" (.254 mm) between the coils of the spring.
7. Tighten the outside jam nut against the inside jam nut. Do not move the inside jam nut.



- 1 - Jam Nuts
- 2 - Springs
- 3 - Actuating Lever

Figure 4.0-11

4.10 How to Adjust the Slip Clutch

After every 100 hours of operation, adjust the slip clutch.

⚠ WARNING: Stop the engine before adjusting the slip clutch.

1. Raise the tractor stand and lower the rear of the tractor to the ground.
2. Remove the quick hitch studs from the quick hitch adapter by turning the studs counter-clockwise. See figure 4.0-12.

NOTE: Use caution when removing the quick hitch adapter. Do not damage the gasket. The gasket must be replaced if there is damage.

3. Remove the quick hitch adapter.

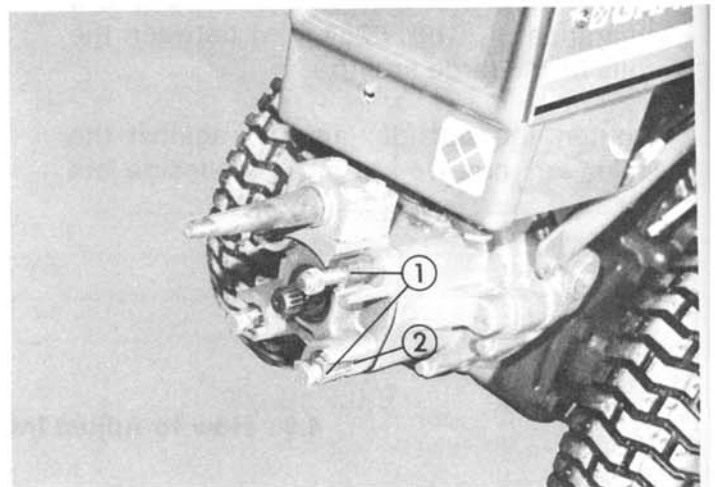

- 1 - Quick Hitch Studs
- 2 - Quick Hitch Adapter

Figure 4.0-12

4. Turn all the jam nuts counterclockwise to loosen the jam nuts. See figure 4.0-13.
5. Turn all the adjusting bolts clockwise until the springs are solid. Then turn all the bolts counterclockwise one-half turn.
6. Tighten the jam nuts against the back plate.
7. Install the quick hitch adapter and the quick hitch studs.

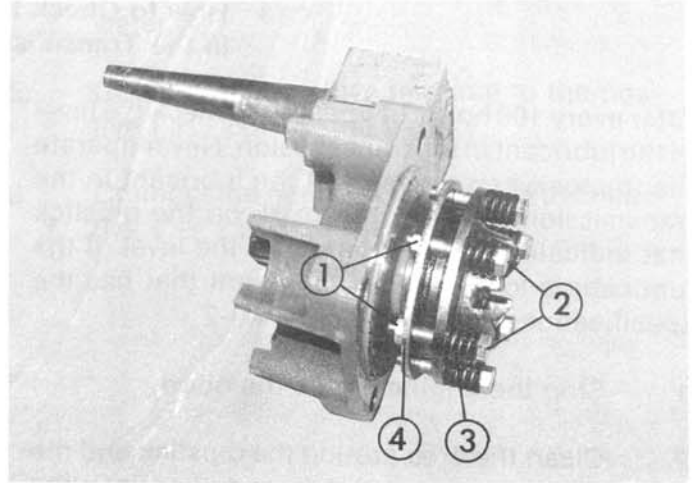

- 1 - Jam Nuts
- 2 - Adjusting Bolts
- 3 - Spring
- 4 - Back Plate

Figure 4.0-13

4.11 How to Replace the Air Cleaner Element

After every 100 hours of operation, replace the air cleaner element.

1. Turn the wing nut on the air cleaner cover counterclockwise. Remove the wing nut and the cover.
2. Clean all the dirt from the air cleaner base and the cover.

3. Install the new air cleaner element carefully to prevent dirt from entering the engine.
4. Install the air cleaner cover and the wing nut.



WARNING: Never operate the engine without the air cleaner element.

4.12 How to Clean the Spark Plug

After every 100 hours of operation, clean the spark plug.

1. Stop the engine. Raise the hood.



WARNING: The muffler and other parts of the engine are hot.

2. Remove the wire connector from the spark plug. Use caution, do not pull the wire from the connector.

NOTE: Spark plugs are easily damaged. If a spark plug has damage it must be replaced.

3. Turn the spark plug counterclockwise with

a socket wrench and remove the spark plug.

4. Remove the dirt and carbon from the spark plug.
5. Use a gauge to check the gap between the electrodes of the spark plug. The correct gap is .025" (.635 mm).
6. Install the spark plug. Tighten the spark plug to a torque of 18 to 22 ft. lbs. (24 to 30 N.m).
7. Install the wire connector on the spark plug.

4.13 How to Check the Level of the Lubricant in the Transmission

After every 100 hours of operation, check the level of the lubricant in the transmission. Never operate the tractor when the level of the lubricant in the transmission is below the mark on the dipstick that indicates the level is low. If the level of the lubricant is low, add new lubricant that has the specifications shown in figure 4.0-2.

1. Stop the engine. Raise the hood.
2. Clean the area around the dipstick and the tube to prevent dirt from falling into the tube. See figure 4.0-14.
3. Pull the dipstick out of the tube and clean the dipstick.
4. Push the dipstick all the way down into the tube.
5. Pull the dipstick out of the tube and look at the level of the lubricant.
6. If the level of the lubricant is below the mark that indicates the level is low, clean the area around the filler plug and remove the plug. See figure 4.0-15.
7. Add lubricant until the level is at the mark on the dipstick that indicates the level is correct.
8. Install the dipstick and the filler plug.



1 - Dipstick
2 - Tube

Figure 4.0-14



1 - Filler Plug

Figure 4.0-15

4.14 How to Clean the Battery

After every 200 hours of operation, clean the battery.

⚠ WARNING: Wear protection for your eyes when cleaning the battery. Always disconnect the negative terminal (“-”) first.

1. Stop the engine. Raise the hood.

2. Loosen the bolt on the negative terminal by turning the bolt counterclockwise. Remove the terminal from the post of the battery. See figure 4.0-8.

⚠ WARNING: Do not let the tool come in contact with the hood or the frame of the tractor.

3. Loosen the bolt on the positive terminal and remove the terminal from the post of the battery.
4. Clean the terminals and the posts of the battery with a solution of sodium bicarbonate (baking soda) and water. Use one unit of baking soda to four units of water.
5. Connect the positive terminal to the positive (“+”) post of the battery.
6. Connect the negative terminal to the negative (“—”) post of the battery.



5.0 HOW TO PUT THE TRACTOR IN STORAGE



When the tractor will not be operated for three months or more, follow this procedure:

1. Do the maintenance as shown in Section 4.0.
2. Close the fuel valve on the fuel tank.
3. Get a clean two gallon (8 liters) fuel container.
-  WARNING: Gasoline is highly flammable.**
4. Remove the fuel line from the fuel pump.
5. Open the fuel valve and drain the gasoline into the fuel container.
6. Connect the fuel line to the fuel pump.
7. Start the engine and let it run until all the fuel in the line is used and the engine stops running. Turn the key in the ignition switch to the "OFF" position.
8. Remove the wire connector from the spark plug and remove the spark plug.
9. Put 20 drops of engine lubricant into the hole for the spark plug.
10. Install the spark plug. Do not install the wire connector on the spark plug
11. Operate the electric starter for five seconds. Operate the manual starter five times.
12. Remove the key from the ignition switch.



6.0 HOW TO TAKE THE TRACTOR OUT OF STORAGE



1. Install the wire connector on the spark plug.
2. Charge the battery if the engine has an electric starter.
3. Put gasoline in the fuel tank.
4. Start the procedure for doing maintenance as shown in Section 4.0.



WARNING: Gasoline is highly flammable.



7.0 HOW TO CHECK FOR PROBLEMS WITH THE TRACTOR



If the tractor has a problem with the engine or with the operation of the tractor, follow the procedures shown in this section. If the cause of the problem can not be corrected, see your Gravely dealer.

7.1 The Electric Starter Will Not Operate

1. Check the fuse for damage. If there is damage, replace the fuse with a BUSS AGE 30 type fuse. See Section 2.10.
2. Clean and tighten the terminals of the battery cables at both ends. See Section 4.14.
3. Check the battery for a discharged condition. Charge the battery or replace the battery.
4. If the battery is in a discharged condition, the engine can be started by using jumper cables if a fully charged battery is available.

Follow this procedure when using jumper cables:

- A. Connect a jumper cable to the positive “+” post on the charged battery and the positive “+” post of the discharged

battery.

- B. Connect one end of the other jumper cable to the negative “-” post of the charged battery. Connect the other end of the cable to the frame of the tractor. Do not connect the cable to any section of the frame that has paint.



WARNING: Do not connect the jumper cable to the negative “-” post on the discharged battery.

- C. Turn the key in the ignition switch to the start position.
- D. When the engine is running, remove the jumper cable from the frame of the tractor and the negative “-” post of the charged battery first. Remove the other cable from the positive “+” post of both batteries.

7.2 The Engine is Difficult to Start or has a Loss of Power

1. Add gasoline to the fuel tank.



WARNING: Gasoline is highly flammable.

2. Check for water or dirt in the fuel tank. Drain and clean the fuel tank.
3. Check the hole in the cap on the fuel tank for dirt. Remove any dirt or other material from the hole.
4. Clean or replace the air cleaner element. See Section 4.3.
5. Clean or replace the spark plug. See Section 4.12.
6. Clean the cooling system. See Section 4.2.
7. Read the Operator’s Manual for the engine and follow the procedures shown in those instructions.

7.3 The Tractor Will Not Move When the Direction Control Lever is Moved

1. The gear shift lever must be in the "HIGH" position or the "LOW" position.
2. Adjust the direction control clutch. See Section 4.8.
3. Adjust the gear shift clutch. See Section 4.9.

7.4 The Attachment Will Not Operate or Operates Slowly

1. Adjust the slip clutch. See Section 4.10.
2. Adjust the gear shift clutch. See Section 4.9.

7.5 The Ammeter Shows that the Electrical System is Discharging

1. Stop the engine immediately.
2. Clean and tighten the connections for the electrical system.

TRACTOR SPECIFICATIONS

Engine

Engine Lubricant Capacity 10 and 12 H.P. Engines 2.0 U.S. qts. (1.9 liters)
8 H.P. Engines 1.25 U.S. qts. (1.2 liters)

Grade API Service SD, SC, or SE

Viscosity Summer - SAE 10W-40
Winter - 0° (-18 C) SAE 5W-20

Electric Starter

Battery SAE Type 17 MI 42 Amp hr. 12 Volt, Negative Ground

Starter Electric

Manual Starter

Starter Recoil Starter

Transmission

Type All Gear Planetary

Transmission Lubricant Capacity 5 U.S. Quarts (4.75 liters)

Grade API Service SD, SC, or SE

Viscosity 10W-40

General Specifications

Fuel Tank Capacity 2 U.S. Gallons (7.6 liters) Frame Installed Tank
9 U.S. Gallons (3.6 liters) Engine Installed Tank

Fuel Type Regular or Unleaded Gasoline

Tire Pressure 18 psi (1.265 Kg per cm²)

GRAVELY TRACTORS LIMITED WARRANTY

This Limited Warranty is issued by Gravelly International, Inc., and consists of the following terms:

1. Only the original purchaser of new Gravelly equipment is covered by this Warranty.
2. This Warranty covers repair or replacement of parts manufactured by Gravelly which are defective in material or workmanship. Gravelly will pay for parts and labor only.
3. The Warranty starts the date of purchase and lasts for TWELVE (12) MONTHS.
4. Some components of Gravelly equipment are not covered by the Gravelly Warranty. These components are covered by the original manufacturer's warranty, which is included with the product. They are:
 - a. Engine - Briggs and Stratton
 - b. Tires - Goodyear and Armstrong
5. To obtain warranty service on Gravelly equipment including components not manufactured by Gravelly, use this procedure:
 - a. Notify the Gravelly dealer from whom you purchased the equipment.
 - b. If you have moved and it is not convenient to notify the selling dealer, notify the nearest Gravelly dealer. You should supply this dealer with a copy of the bill of sale as proof of the date of purchase.
 - c. Make arrangements to have the equipment delivered to the dealer (refer to paragraph 6(a) below).
 - d. If you have any questions concerning the Gravelly Limited Warranty, they should be referred to:

Gravelly International, Inc.
One Gravelly Lane
Clemmons, NC 27012

Attn: Manager of Customer Services
 - e. Warranty service on Gravelly equipment must be performed by an authorized Gravelly dealer or Gravelly factory branch.
6. This Warranty does not cover the following:
 - a. Transportation between owner's home or place of business and the dealership. If the dealer provides the transportation of the equipment, he will charge the owner his usual rate for such service.
 - b. Normal maintenance services and normal replacement of items such as spark plugs, belts, oil, oil filters, air filters, and mower blades.
7. GRAVELLY MAKES NO OTHER EXPRESS WARRANTIES. ANY IMPLIED WARRANTIES, INCLUDING WARRANTIES AS TO MERCHANTABILITY OR FITNESS FOR A PARTICULAR PURPOSE, ARE LIMITED IN DURATION TO THE PERIOD SET OUT IN PARAGRAPH 3 ABOVE. SOME STATES DO NOT ALLOW LIMITATIONS ON HOW LONG AN IMPLIED WARRANTY LASTS, SO THE ABOVE STATEMENT MAY NOT APPLY TO YOU.
8. GRAVELLY SHALL HAVE NO RESPONSIBILITY FOR INCIDENTAL OR CONSEQUENTIAL DAMAGES RESULTING FROM THE BREACH OF ANY WARRANTY, INCLUDING, BUT NOT LIMITED TO, INCONVENIENCE, RENTAL OR PURCHASE OF REPLACEMENT EQUIPMENT, LOSS OF PROFITS OR COMMERCIAL LOSS. SOME STATES DO NOT ALLOW THE EXCLUSION OR LIMITATION OF INCIDENTAL OR CONSEQUENTIAL DAMAGES, SO THE ABOVE LIMITATION OR EXCLUSION MAY NOT APPLY TO YOU.
9. This Warranty gives you specific legal rights, and you may have other rights which vary from state to state.
10. A Gravelly product registration card is supplied with each Gravelly product. Please complete the card and return it to Gravelly at the address listed on the card. The equipment registration card will be used by Gravelly for:
 - a. Recording date of purchase.
 - b. Notification of owners in compliance with the Consumer Product Safety Act, should any notification be necessary.The return of registration card is not required in order to take advantages of this Warranty.
11. This Warranty is not subject to change or modification by anyone, including Gravelly dealers and no Gravelly dealer is authorized to make any representations or promises on Gravelly's behalf.



One Gravelly Lane, Clemmons, NC 27012